

OPERATING GUIDE

AMPLIFIER ELECTRONICS PD3



Inhaltsverzeichnis

1	General information	3
2	Product description	4
2.1	General	4
2.2	Field of Application.....	4
2.3	Conformity	4
2.4	Type code	5
2.5	Technical data.....	5
2.6	Block diagram.....	7
2.7	Dimensions	8
3	Safety rules	9
3.1	Installation / Commissioning / Parameterisation.....	9
4	Construction and Function	10
4.1	Introduction	10
4.2	Description of the Function.....	10
4.3	Temperature monitoring.....	12
4.4	Enable input.....	13
4.5	Command input.....	13
4.6	Output	13
4.7	Power reduction.....	14
5	Operating and indication	15
5.1	General	15
5.2	Bluetooth Low Energy interface	15
5.3	IO-Link interface.....	15
5.4	Connector cable.....	16
5.5	Operating- and indication elements	17
6	Commissioning	19
6.1	Type Analog	19
6.2	Type IO-Link	22
7	Settings	24
7.1	Introduction	24
7.2	Tips for the first commissioning.....	24
7.3	Factory settings.....	25
7.4	Parameter	26
7.5	Wandfluh App.....	30
8	System does not work	35
8.1	Procedure	35
9	Disposal	36
10	Accessories	37
11	Additional information	38

1 General information

This operating instructions makes it possible to use the PD3 Electronics safely and according to specification. The operating instructions includes instructions which Wandfluh as the manufacturer, or its resale organisations (Wandfluh sister companies or distributors), provide to users within their duty to instruct.

For this purpose, the operating instructions mainly includes:

- information about use according to specification, installation and commissioning of the PD3 Electronics
- information about safety in dealing with control.

2 Product description

2.1 General

The PD3-Electronics is available in two different versions:

- **direct mounted on the solenoid**

The PD3-Electronics is mounted direct on the solenoid can not be removed. No additional connection is necessary to the solenoid. The connection for power supply, command value etc. takes place via the fixed mounted 5pol cable with molded M12 connector.

See solenoid data sheet 1.1-332 in the official Wandfluh documentation:

<https://www.wandfluh.com/products/detail/mt-p1/>

- **with additional solenoid cable**

The PD3-Electronics is connected to the solenoid via the fixed mounted solenoid cable. The solenoid cable has flying leads. Therefore any available connector type can be mounted (ATTENTION: connector is not part of the scope of delivery!). The connection for power supply, command value etc. takes place via the fixed mounted 5pol cable with a molded M12 connector.

Also see PD3 data sheet 1.13-66 in the official Wandfluh documentation:

<https://www.wandfluh.com/products/detail/pd3401d80-a/>

2.2 Field of Application

Because of the compact form of construction, the field of application of the PD3-Electronics is situated in the industrial field as well as in the mobile field.

2.3 Conformity

The PD3 Electronics has been developed and tested in accordance with the latest technical standards.

Applied in particular was the EU Guideline EN 61 000-6-2 (Immunity) and EN 61 000-6-4 (Emission).

Concerning Bluetooth, the PD3 Electronics fulfills the following specifications:

- 2014/53/EU (Radio Equipment Directive)
- ETSI EN 300 328
- 47 CFR, Part 15 / ICES-003
- ETSI EN 301 489-1 / 301 489-17
- built-in Bluetooth Module: FCC ID: QQQ11

2.4 Type code

This type code only applies to the version with additional solenoid cable. For the direct mounted version the type code of the solenoid / valve is valid.

TYPE CODE

		P D3 4 0 1 D8 0 - A <input type="checkbox"/> <input type="checkbox"/> # <input type="checkbox"/>
Connector		
Digital		
Adjustable via Bluetooth by means of the App		
Basic amplifier		
1-solenoid execution		
Supply voltage	8...32V (IO-Link: only 24V)	
Command value input	Voltage / current / digital / frequency / PWM	only [A] analogue
12-bit resolution	For analogue input	
Type selection:		
• IO-Link	<input type="checkbox"/> I Standard	
• Only analogue	<input type="checkbox"/> A	
• CANopen	<input type="checkbox"/> C on request	
• J1939	<input type="checkbox"/> J on request	
Connection cable	<input type="checkbox"/> 1.5 m, with M12 plug	
Design index (subject to change)		

2.5 Technical data

2.5.1 General specifications

Execution	Direct mounted on the solenoid or with additional solenoid cable	
Connections	Connecting cable Solenoid cable (only version with additional solenoid cable)	5pol cable 1.5m for power supply, command value, etc with molded M12 connector (male) 2pol cable (0.5m) without solenoid connector
Ambient temperature	-40 ... +85 °C	under difficult circumstances, at higher temperatures, the solenoid current and with it the valve performance can be reduced (refer to section " Temperature monitoring " ^[12])
Protection class	IP67 to EN 60 529	

2.5.2 Electrical specifications

Supply Voltage VCC	Type IO-Link: 24V (18 ... 30V) Type Analog: 8 ... 32V
Ripple on Supply Voltage	< 1.3 Vpp
Fuse	The PD3-Electronics must be protected by a slow fuse on the user side
Temperature Drift	< 1% with $\Delta T = 40^\circ \text{C}$
No load current	ca. 50 mA
Maximum current consumption	no load current + max. 2.5 A pro Magnet
Command input	1 input single ended 0 ... +10 VDC voltage/current switchable 0/4 ... 20 mA Resolution 12 Bit Input resistance for voltage input > 100 kOhm Analog input also usable as frequency input or as PWM input (automatic frequency identification), 5 ... 5000 Hz or as digital command signal - dig. switching threshold high > 3 V - dig. switching threshold low < 0.8 V Burden at current input 124 Ohm
Enable Input (only on Analogue type PD3)	1 input active high - switching threshold high $1/2 V_{CC} + 2V$ - switching threshold low $1/2 V_{CC} - 2V$
Bluetooth Interface	Low Energy mit access protection contains Bluetooth module FCC ID: QQQ11
IO-Link Interface (only on IO-Link type PD3)	IO-Link version v1.1 baudrate COM2 (38.4 kBaud) class Device Class B profile Common Profile The PD3-IO-Link requires an IO-Link Master type B , which provides the current for the solenoid
Stabilised output voltage (only on Analog type PD3)	+ 5 VDC max. Belastung 20 mA Caution for the Analog type PD3: danger of short circuit when using M12 distribution boxes which have Earth on Pin 5
Solenoid current	minimum current I _{min} adjustable 0 ... I _{max} mA default setting 50 mA maximum current I _{max} adjustable I _{min} ... 2500 mA default setting: 700 mA
Dither	dither frequency adjustable 4 ... 500 Hz default setting 80 Hz dither Level adjustable 0 ... 400 mA default setting 180 mA
EMC	2014/53/EU (Radio Equipment Directive) ETSI EN 300 328 47 CFR, Part 15 / ICES-003 ETSI EN 301 489-1 / 301 489-17
Immunity	EN 61000-6-2
Emission	EN 61000-6-4

2.6 Block diagram

I: pin assignment for IO-Link type
 A: pin assignment for Analog type
 C/J: pin assignment for CAN/J1939 type

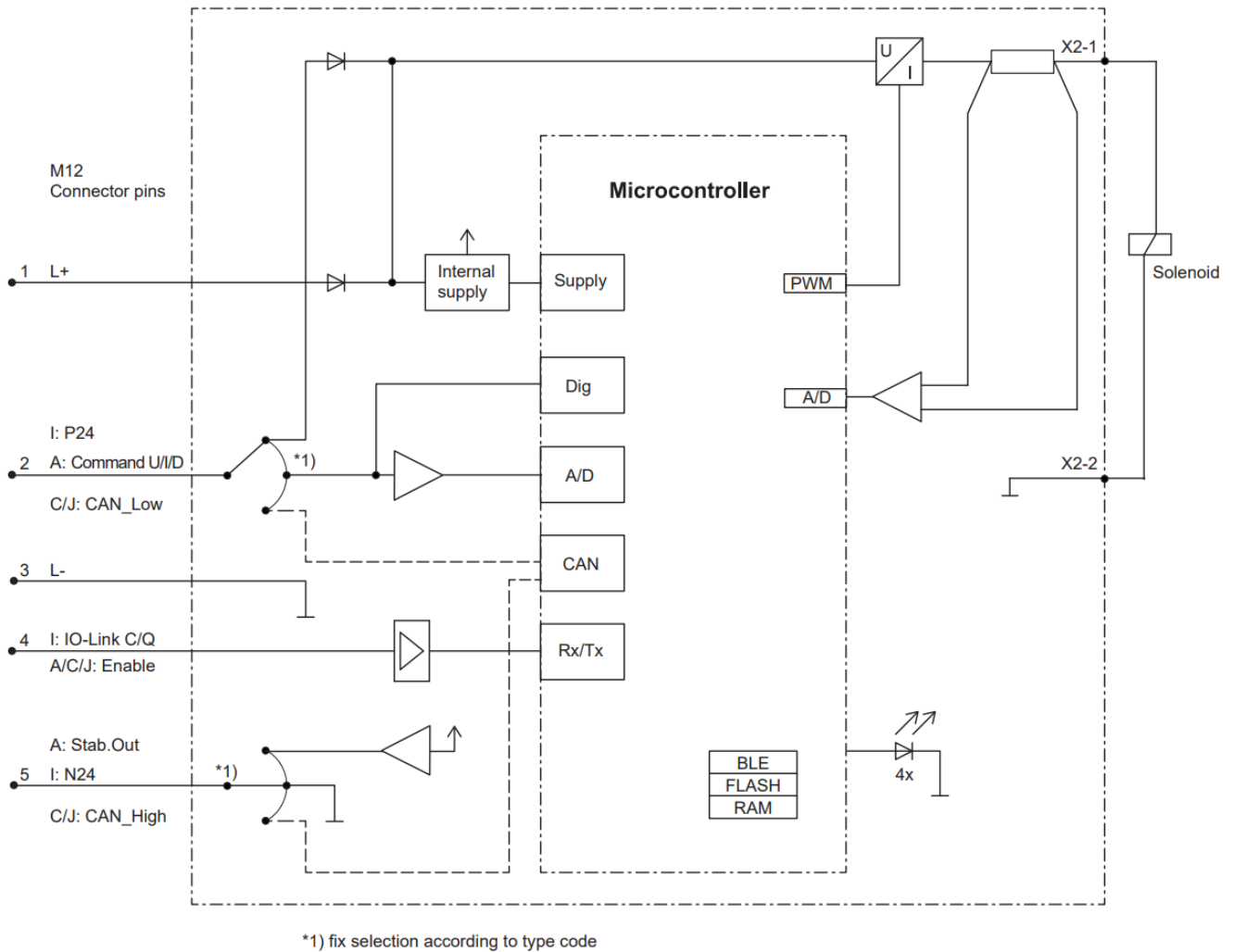

2.7 Dimensions

direct mounted on the solenoid coil:

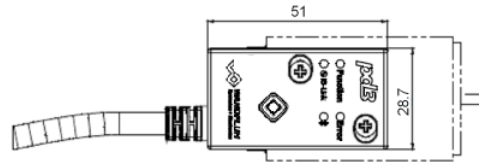
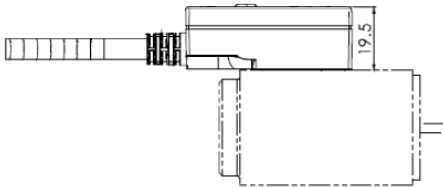

Connecting cable = 1.5m
with molded M12 connector

with additional solenoid cable:



Connecting cable = 1.5m
with molded M12 connector

Solenoid cable = 0.5m
without solenoid connector

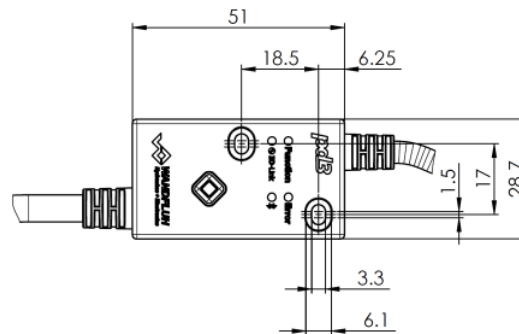

3 Safety rules

3.1 Installation / Commissioning / Parameterisation

- These operating instructions have to be carefully studied beforehand and the instructions are to be complied with.
- Prior to the installation, all power supply voltages and any other energy sources have to be disconnected.
- The installation/assembly must only be carried out by specialist personnel with electrical knowledge.
- Take into account precautionary measures concerning components on the module, which are subject to damage as a result of electrostatic discharge.
- Wrong manipulations by the personnel cannot be prevented by the PD3 Electronics.
- Before the switching on of the supply voltage, the fuse protection, the correct wiring and the conformity of the power supply voltage with the permissible supply voltage range have to be verified.



- **The PD3 Electronics monitors the working conditions within the electronics and within the installation. Uncontrolled movements or force changes caused by unforeseen errors of the PD3 Electronics cannot be prevented in any case.**
- **Danger for persons has to be avoided by installing an emergency stop device which cuts off the power to the system.**

4 Construction and Function

Refer to section "[Block diagram](#)" ⁷.

4.1 Introduction

- All inputs have to be contacted through the 5pol cable with the molded M12 connector.
- For the PD3 the version with additional solenoid cable, the solenoid has to be contacted through the 2pol cable (the customer has to assemble the mating solenoid coil connector)
- For the PD3 type on the solenoid, PD3 and solenoid are soldered, and the PD3 cannot be disassembled
- Parametrisation and Diagnostics can be done with the Wandfluh App via Bluetooth.

4.2 Description of the Function

The PD3 Electronics has one command input and one solenoid coil output.

The utilisation of the input, the functions of the electronics, and the control of the solenoid coil can be adjusted individually.

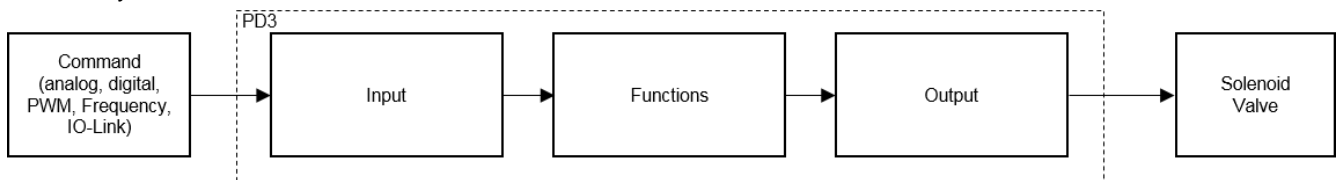

With the Analogue type PD3, the command input accepts voltage, current, frequency and PWM signals. The scaling of the signals can be adjusted individually.

With the IO-Link type PD3, the command input only accepts the IO-Link signal from the IO-Link connection. The external command signal is scaled into an internal command signal of 0..100%, and this internal command generates the output current of I-min .. I-max solenoid current

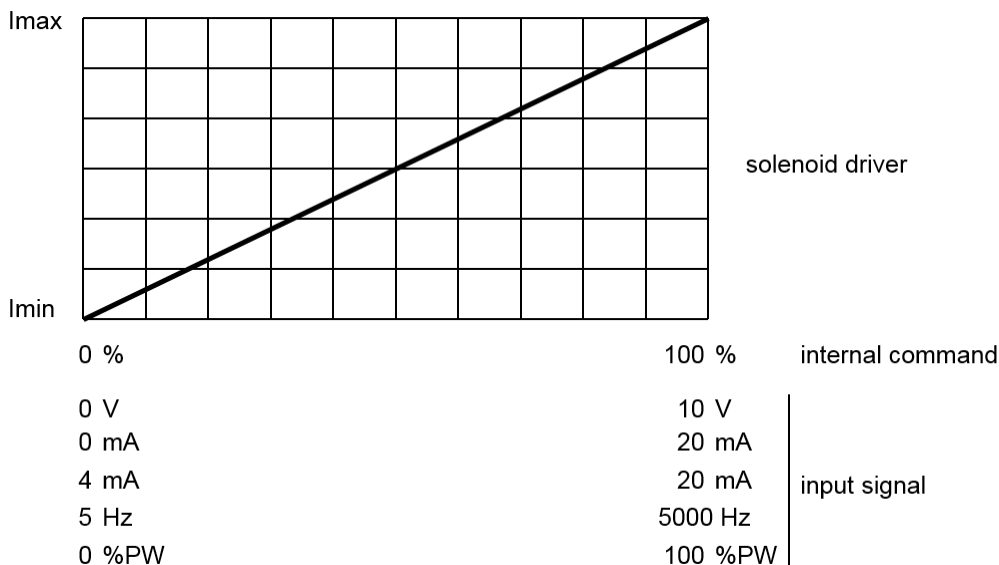

The solenoid outputs have a PWM current output **pulse-width-modulated** at 1000 Hz with superimposed, adjustable dither.

The output can drive either a proportional solenoid or an on/off switching solenoid.

Minimum and maximum solenoid current, or the output pulse width range can be adjusted.

For the switching solenoid, the PD3 electronics offers an adjustable power reducing function.

The parametrisation and diagnosis takes place via the wireless Bluetooth connection to the Wandfluh App on the smartphone.

All parameter settings are saved permanently in a non-volatile memory on the PD3, so that they are available also after a power down/power up of the PD3.

The Wandfluh App also allows to store the parameter setting to a parameter file, so that it can be used again.

4.3 Temperature monitoring

The PD3-electronics are provided with an internal, factory set temperature monitoring, which can limit the solenoid current to prevent the overheating of the electronics.

Which means that at higher ambient temperature and high solenoid temperature, the full solenoid current cannot be reached anymore.

Starting from a temperature threshold of 80 °C of the internal electronics temperature, the set max. solenoid current (I_{max} , see section "[Parameter Output](#)"^[29]) is limited depending on the temperature.

The temperature of the PD3 electronics is visible in the dashboard of the Wandfluh App.

Since the self-heating of the solenoid, on which the PD3 electronics can be mounted, has an significant influence on the electronics temperature, this current limiting reduces the electronics temperature and allows electronics to be run at higher ambient temperatures, but with reduced solenoid current.

With active 'derating' the valve operating range is restricted – the effect complies with that of a reduced command value signal range (refer to the valve data sheet).

REMARK:

If the monitored electronics temperature exceeds the boundary of 90°C, the PD3 is switched into the error state.

The solenoid outputs will be blocked in order to prevent permanent damage of the electronics.

After cooling off and acknowledging the error (refer to chapter "[The system does not work](#)"^[35]) the PD3 can be enabled again.

The derating/limiting of the current is depending on

- ambient temperature (lower temperature is better)
- supply voltage (higher voltage is better)
- solenoid type (smaller solenoid with lower wattage is better)
- PWM duty cycle (smaller current is better)

Solenoid current vs. ambient temperature.

blue line: best case

red line : worst case

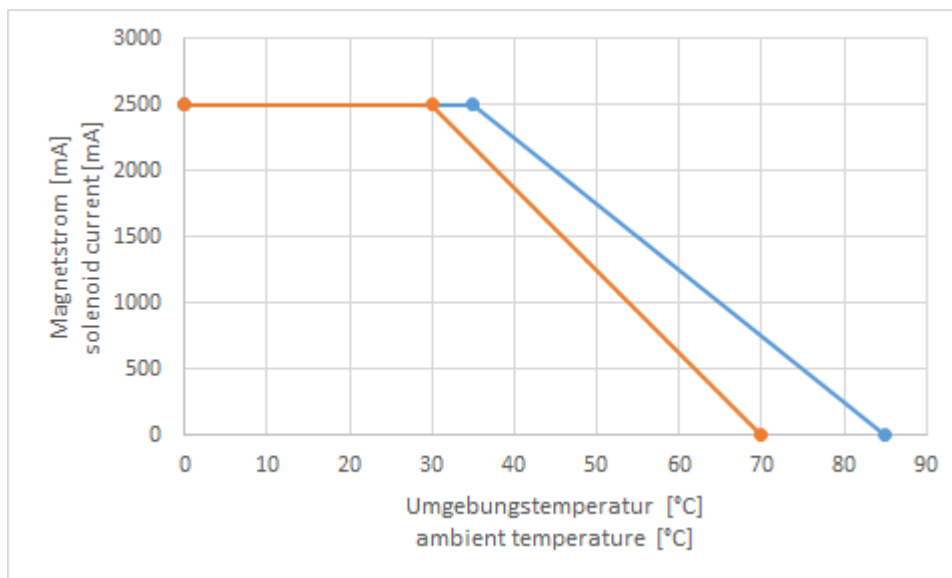

PD3 temperature derating

4.4 Enable input

On the analogue type PD3, the digital enable-input can be used as the enable function for the PD3 electronics.
On the IO-Link type PD3, the device is enabled via IO-Link bus.

4.5 Command input

The command input is used for analogue command signals as well as for digital signal.
The Wandfluh App allows to choose the desired functionality and scaling.

The following signal types can be selected:

- voltage
- current
- digital (1 / 0)
- frequency
- PWM
- Bus

The applied analogue signal is digitised with a resolution of 12 Bits over the full range.

Attention: When using a signal range lower than the maximum adjustable range, then the resolution will be lower than 12 Bit; (e.g. when using 4...20mA or 0...5V)

When using a potentiometer or joystick as the voltage command signal, then we suggest to use a 5 kOhm resistance.

4.6 Output

The solenoid output has a PWM current output **pulse-width-modulated** at 1000 Hz with superimposed, adjustable dither.

The output can drive either a proportional solenoid or an on/off switching solenoid.

Minimum and maximum solenoid current, or the output pulse width range can be adjusted.

For the switching solenoid, the PD3 electronics offers an adjustable power reducing function.

Depending on the selected solenoid type, the solenoid current control is either switched on or switched off:

- proportional solenoid = current control switched on
- switching solenoid = current control switched off

Caution: when using a switching solenoid (with current control switched off), then please ensure that current stays within the maximum permissible current range of the PD3. Otherwise the PD3 will recognise an overcurrent and go into short circuit error.

4.7 Power reduction

When selecting the solenoid type "switching solenoid", then the PD3 offers an adjustable power reduction function.

When the solenoid is switched on, the full solenoid current (= nominal current of the solenoid) will flow during the adjusted time (Parameter "Reduction time"). Thereafter, the current is limited to the reduced value (Parameter "Reduced value"). The reduced value refers to the nominal current of the solenoid (100% = nominal current, 50% = half nominal current).

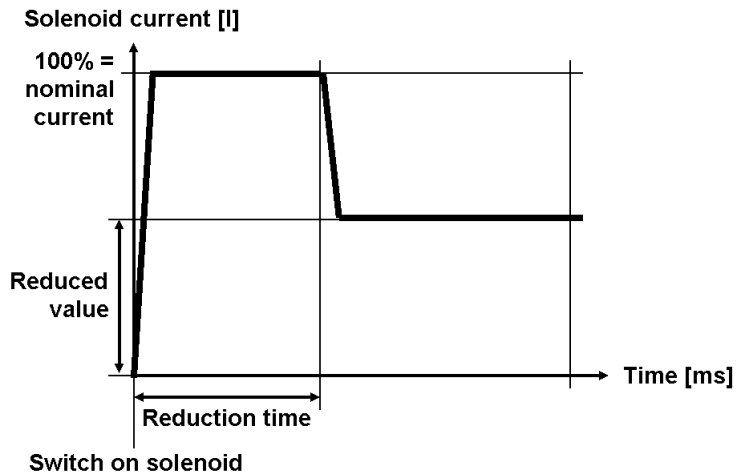

5 Operating and indication

5.1 General

Die PD3 electronics has a control button and indication LEDs directly on the device cover. In addition, there is a Bluetooth low energy interface for the Wandfluh App, and the IO-Link type PD3 features the IO-Link interface.

5.2 Bluetooth Low Energy interface

The Bluetooth low energy interface allows the communication to the Wandfluh App, which is used for parametrisation and diagnostic analysis of the PD3 electronics.

Please refer to section [Wandfluh App](#)^[30] for information about the functionality of the App.

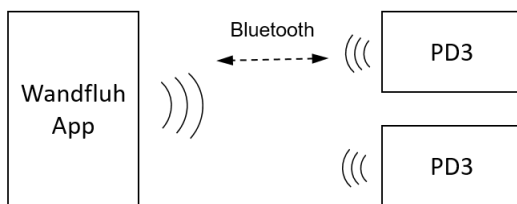

The Bluetooth interface is only enabled after the power-up of the PD3 electronics, or after pushing the button on the PD3 cover.

See section [Control- and indication elements](#)^[15] for further details.

After a certain time of inactivity, the Bluetooth interface is deactivated. This is a security feature and prevents unintentional access to the PD3 electronics. The time span before the interface is deactivated can be adjusted with the Wandfluh App,

In addition, the parameters can be protected against unauthorized changes with a password. The connection to the PD3, the diagnostics and reading of parameters is possible without entering the password. see section [Settings](#)^[34].

5.3 IO-Link interface

Only the IO-Link type PD3 offers the IO-Link interface, which can be used both to control the PD3, and also to set parameters and read diagnostic data.

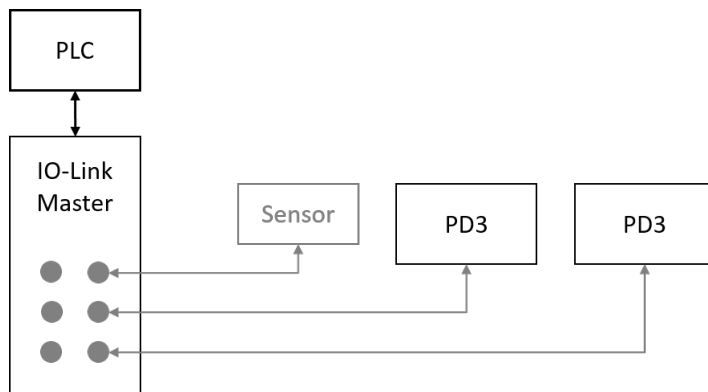

Please find further information about IO-Link in section "[Typ IO-Link](#)"^[22], and in the separate document "PD3 IO-Link Interface Description" on the PD3 product page on our website.

<https://www.wandfluh.com/products/detail/pd3401d80-a/>

5.4 Connector cable

Type Analog

Caution: danger of short circuit when using M12 distribution boxes which have Earth on Pin 5

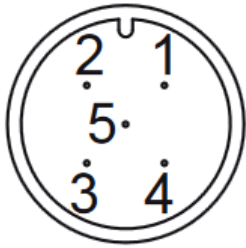

M12 connector X1, 5-pin male,
molded to the cable

M12 pins (wire color)

1 (brown):	supply voltage VCC+
2 (green):	command value
3 (grey)	supply voltage 0V DC
4 (white)	enable input
5 (yellow)	stabilized output voltage

Type IO-Link

an IO-Link master class B must be used (with additional supply for the solenoid)

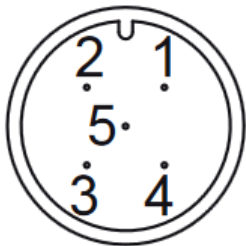

M12 connector X1, 5-pin male,
molded to the cable

M12 pins (wire color)

1 (brown):	L+, supply voltage+
2 (green):	P24/2L+, additional supply+ (for solenoid power)
3 (grey)	L-, supply voltage 0V DC
4 (white)	C/Q (IO-Link data)
5 (yellow)	N24/2L-, additional 0V DC (for solenoid power)

solenoid cable (loose type PD3 only)

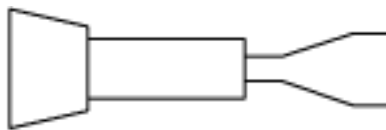

Solenoid cable X2
flying leads

1 (brown):	solenoid output +
2 (white)	solenoid output -

5.5 Operating- and indication elements

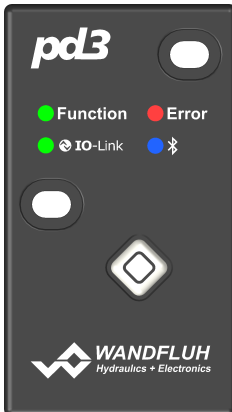

Function LED (green)

the device is powered and ready

Error LED (red)

shows an active error (flashing ocde)

IO-Link LED (green)

type IO-Link: IO-Link state

type analogue: enable input on

Bluetooth LED (blue)

state of the Bluetooth interface

Button (◆)

push to activate the Bluetooth interface, or perform a factory reset

5.5.1 Push button

The push button on the PD3 electronics has two functions:
 activating the Bluetooth interface, or perform a factory reset:

- **Bluetooth interface**

The Bluetooth interface is only enabled after the power-up of the PD3 electronics, or after pushing the button on the PD3 cover.

After a certain time of inactivity, the Bluetooth interface is deactivated.

This is a security feature and prevents unintentional access to the PD3 electronics.

The time span before the interface is deactivated can be adjusted with the Wandfluh App, see section [Settings](#)^[34].

- **Factory Reset**

To perform a factory reset (set all parameters to Wandfluh factory default settings and clear the access password),

push and hold the button during the power-up of the PD3 electronics.

The blue Bluetooth LED indicates the begin of the factory reset by flashing fast.

After the successful factory reset, the blue Bluetooth LED will be constantly ON.

Now the push button can be released, and the PD3 will perform a restart.

5.5.2 Function LED

The green Function LED is ON as soon as the PD3 Electronics has started up.

5.5.3 Error LED

Any PD3 error is indicated by the flashing red LED.

See section [System does not work](#)^[35] for the description of the flashing code.

5.5.4 IO-Link LED

PD3 type IO-Link

The green IO-Link LED shows the state of the IO-Link connection with a flashing code.

LED on/off ratio	IO-Link Phase
2% on	STARTUP oder disconnected getrennt
50% on	PREOPERATE
100% on	OPERATE

PD3 type Analog:

The green LED shows the state of the digital Enable input.

LED on = Enable input active (PD3 is enabled)

LED off = Enable input not active (PD3 is disabled, no solenoid current flows)

5.5.5 Bluetooth LED

The blue Bluetooth LED shows the state of the Bluetooth connection

LED off	Bluetooth interface is off. No connection to the PD3 is possible --> press the push button to activate the Bluetooth interface
LED flashing	Bluetooth interface is activated, and waiting for the Wandfluh App to connect.
LED on	The Bluetooth connection to the Wandfluh App is active and running.

6 Commissioning

Please see section "[safety rules](#)"⁹.

The contact pin assignment of the following descriptions is related to section "[Connection](#)"¹⁶.

For an **installation / connection appropriate for EMC**, the following points absolutely have to be observed:

- Solenoid- and signal cables must not be laid parallel to high voltage cables.

6.1 Type Analog

Caution: Danger of short circuit when using an M12 distribution box which has Earth on Pin 5

Connection example for the Analog type PD3 with the stabilized output voltage to supply the command potentiometer. Enabled with the digital Enable input.

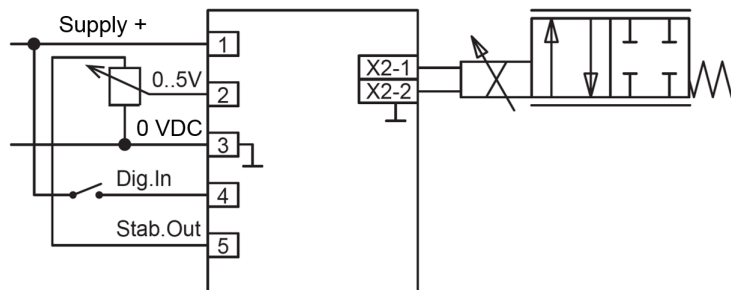

Connection example for the Analog type PD3 with an external 0 / 4 .. 20mA command signal. Digital enable input not used; PD3 is permanently enabled by the setting with the App.

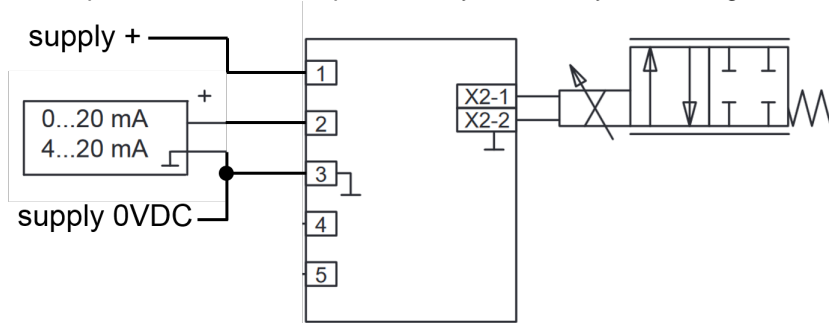

Connection example for the Analog type PD3 with an external 0 .. +10V command signal. Digital enable input not used; PD3 is permanently enabled by the setting with the App.

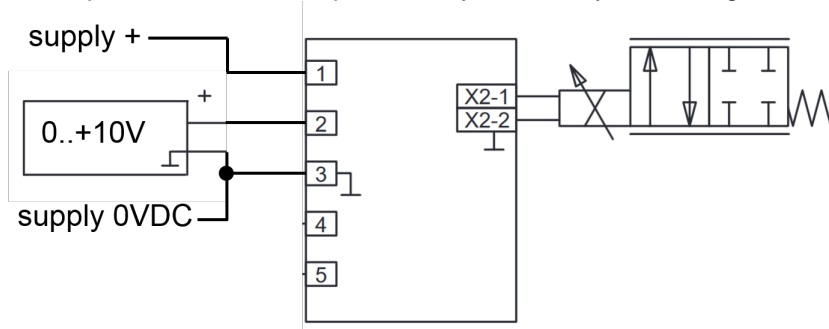

6.1.1 Supply voltage

- For the dimensioning of the power supply the maximum current demand of the solenoids (in case of directional control valves only the maximum current demand of 1 solenoid) has to be increased by the no-load current of the PD3-Electronics
- The limit values of the supply voltage and its residual ripple have to be observed indispensably
- refer to section "[Electrical Characteristics](#)" ^[6]
- The PD3-Electronics have to be fuse protected with a slow-blow fuse.

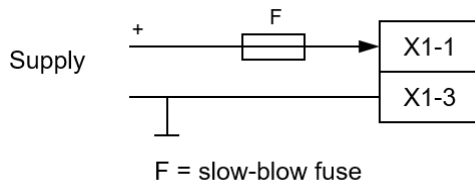

6.1.2 Enable input

The digital Enable input is only available on the analogue type PD3.
On the IO-Link type PD3, this pin is used for the IO-Link data (C/Q-Signal).

This input can only be used to Enable the function/output of the PD3 Electronics (see [Enable](#) ^[26]).

This digital Enable input is a normal "active-high" input:

- "Enabled" means that the voltage must be higher than $1/2 VCC + 2V$ (e.g. the supply voltage)
- "Disbaled" means that the voltage must me lower than $1/2 VCC - 2V$ (e.g. connect to 0V GND)
- when left open, the state of the digital input is not defined !
- The green IO-Link LED indicates the state of the input

6.1.3 Command input

- The command value input accepts a voltage, current, frequency, PWM or a digital command signal.
- The selection of the input signal type must be done with the Wandfluh App, with the parameter "signal type" (see section [Input](#)^[26])

Connection examples for the command input

- voltage command with potentiometer (preferred resistance: 5k Ohm).
e.g. potentiometer supplied by the PD3's stabilized output:

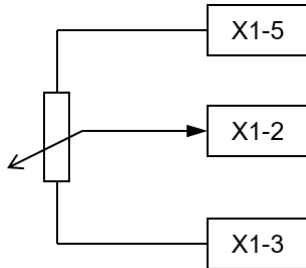

- voltage command from an external source, e.g. from a PLC:

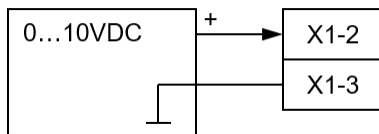

- current command from an external source, e.g. from a PLC:

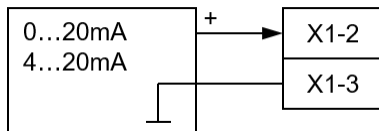

6.1.4 Solenoid output

- The solenoid output is able to measure the solenoid current.
- If the "solenoid type" is set to "Proportional solenoid", the the solenoid current is measured and controlled.
- If the "solenoid type" is set to "switching solenoid", then the solenoid current is not measured.
- See section ["Output"](#)^[29] for the settings.

6.2 Type IO-Link

Connection example of the IO-Link type PD3

Hint:

an IO-Link **master class B** has to be used.

Only these masters are equipped with the separate P24/N24 voltage output and can deliver the high current required by the solenoid coil

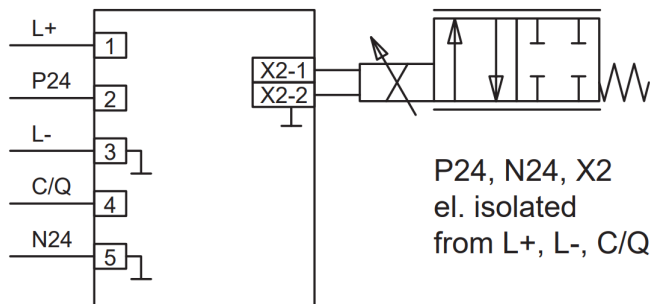

6.2.1 Supply voltage

- For the dimensioning of the power supply the maximum current demand of the solenoids (in case of directional control valves only the maximum current demand of 1 solenoid) has to be increased by the no-load current of the PD3-Electronics
- The limit values of the supply voltage and its residual ripple have to be observed indispensably
- refer to section "[Electrical Characteristics](#)" [6]
- The Logic part of the PD3 (Controller and IO-Link) is isolated from the solenoid part
- Refer to the IO-Link master specification on how to protect the PD3 from over-current
- Wiring/Pin connection according to the IO-Link specification

Hint:

an IO-Link **master class B** has to be used.

Only these masters are equipped with the separate P24/N24 voltage output and can deliver the high current required by the solenoid coil

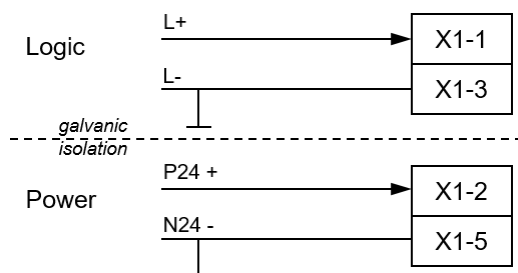

6.2.2 Command input

The command value is transmitted as a digitally coded signal over IO-Link, over the C/Q wire pin.

IO-Link version	v1.1
baudrate	COM2 (38.4 kBaud)
class	Device Class B
profile	Common Profile
backup & restore	supported

See the "PD3 IO-Link Interface Description" on the PD3 landing page on the Wandfluh website.

<https://www.wandfluh.com/products/detail/pd3401d80-a/>

6.2.3 Solenoid output

- The solenoid output is able to measure the solenoid current.
- If the "solenoid type" is set to "Proportional solenoid", the the solenoid current is measured and controlled.
- I the "solenoid type" is set to "switching solenoid", then the solenoid current is not measured.
- See section "[Output](#)"^[29] for the settings.

7 Settings

Please see section ["safety rules"](#)^[9].

7.1 Introduction

- The system- and parameter settings are done with the Wandfluh App, or with IO-Link.
- See section [Wandfluh App](#)^[30] for Installation and Operation of the App.
- See the "PD3 IO-Link Interface Description" on the PD3 landing page on the Wandfluh website.
<https://www.wandfluh.com/products/detail/pd3401d80-a/>

7.2 Tips for the first commissioning

- Connect the power supply, leave the Wandfluh-Electronics still switched-off
- Switch-off the hydraulic drive (hydraulics switched-off)
- Carefully check the connections
- Switch-on the power supply
- Establish communication with the Wandfluh App
 1. Select Enable function in ["Enable input"](#)^[26]
 1. Select input signal type and command scaling in ["Input"](#)^[26]
 3. Make the corresponding settings in the box ["Function"](#)^[28]
 4. Make the corresponding settings in the box [Output](#)^[29]
- Switch-on the hydraulic drive (hydraulics switched-on)

7.3 Factory settings

The PD3 Electronics is parametrised with the following factory default settings

Parameter	Analog type PD3	IO-Link type PD3
Enable input	digital Enable Input	Bus
<i>Input</i>		
Command signal type	voltage	Bus
Min Interface	0.00 V	0
Max Interface	5.00 V	10'000
Deadband	0.0 % (off)	-
<i>Function</i>		
Ramp up	0.0 s	0.0 s
Ramp down	0.0 s	0.0 s
Enable fixed command value	off	-
fixed command value	0.0 %	-
<i>Output</i>		
Solenoid type	proportional solenoid	proportional solenoid
Cablebreak monitoring solenoid	off	off
Imin	50 mA	50 mA
Imax	700 mA	700 mA
Dither frequency	80 Hz	80 Hz
Dither level	180 mA	180 mA
ON threshold (switching solenoid)	80.0 %	80.0 %
OFF threshold (switching solenoid)	20.0 %	20.0 %
Reduction time (power reduction switching solenoid)	250 ms	250 ms
Reduced value (power reduction switching solenoid)	50.0 %	50.0 %
<i>Settings</i>		
Button (Bluetooth interface activation time)	5 min	5 min
Device name on Bluetooth	Axxxxxxxxx (A + serial number)	Ixxxxxxxxx (I + serial number)
Password protection to change parameter values	standard setting: OFF	standard setting: OFF

See section [Parameter](#)²⁶ for the detailed description of the parameters.

7.4 Parameter

All Parameters and settings can be changed via wireless Bluetooth connection with the Wandfluh App on a smartphone/Tablet.

7.4.1 Enable

To change any of the PD3 parameters, the Enable signal usually needs to be switched OFF. In this Tab, the Enable function can be changed at all times.

Field	Parameter description	Range / Step
Enable	Enable the function and output of the PD3 electronic. With the selection "off", the device is disabled and no solenoid current will be active. With the selection "on", the device is permanently enabled, and the solenoid output is operated according to the command input. With the selection "digital", the Enable signal is done with a high signal at the digital Enable input (input active = enable) With the selection "digital inverted", the Enable signal is done with a low signal at the digital Enable input (input not active = enable) On the IO-Link type, the selection is set to "bus". On IO-Link types, the enable signal must be sent over IO-Link.	off on digital digital inverted Bus

7.4.2 Input

This Tab allows you adjust all settings for the Command input.

Field	Parameter description	Range / Step
Signal type	On the Analoge type PD3, this Field lets you select the desired command signal type. Bus: fix set to "Bus" on IO-Link types only	voltage current digital frequency PWM Bus
Min. Interface	corresponds to the input signal value for 0% command Signal type = voltage Signal type = current Signal type = digital Signal type = frequency Signal type = PWM Signal type = Bus When changing the parameter "signal type", the value of the "Min.Interface" is reset to factory settings)	0 ... 10V 0 ... 20mA 0 ... 1 5 ... 5000Hz 0 ... 100%PW 0

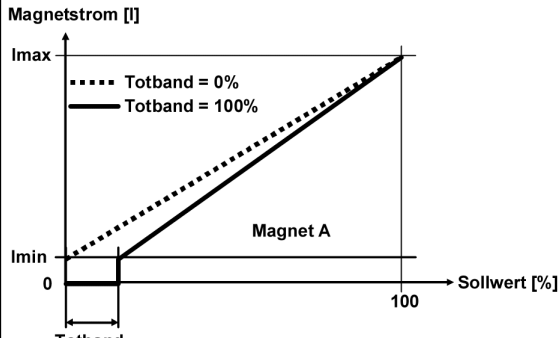
Field	Parameter description	Range / Step
Max. Interface	corresponds to the input signal value for 100% command Signal type = voltage Signal type = current Signal type = digital Signal type = frequency Signal type = PWM Signal type = Bus When changing the parameter "signal type", the value of the "Max.Interface" is reset to factory settings)	0 ... 10V 0 ... 20mA 0 ... 1 5 ... 5000Hz 0 ... 100%PW 10'000
Deadband	Command < Deadband = 0mA solenoid current Command >= Deadband = Imin .. Imax solenoid current 	0 ... 100%

Default values for the scaling parameters

	signal type			
	voltage	current	frequency	PWM
Min. Interface	0 V	0 mA	5 Hz	5 %PW
Max. Interface	5 V	20 mA	5000 Hz	95 %PW

7.4.3 Functions

This Group allows to change the function parameters (Ramp times).

Field	Parameter Description	Range / Step
Ramp up	The set ramp time refers to a command value jump from 0% to 100% for the solenoid output. With a value of 0s, the ramp function is disabled.	0 ... 500s
Ramp down	The set ramp time refers to a command value jump from 100% to 0% for the solenoid output. With a value of 0s, the ramp function is disabled.	0 ... 500s
Enable fixed command value	When "off", the fixed command value function is disabled. When "on", the fixed command value function is enabled, and the pre-defined value can be selected with the command input. The signal type will automatically be adapted to "digital". (see signal type in menu Input ^[26]).	on / off
Fixed command value	Value of the fixed command value. The pre-defined percentage value is related to the range of the solenoid current: (0% = 0mA, 0.1% = I _{min} , 100% = I _{max}).	0 ... 100%

7.4.4 Output

This Group allows to change the parameters of the solenoid output driver.

Field	Parameter description	Range/ Step
Solenoid type	selection of the solenoid type	proportional solenoid switching solenoid

The following settings can only be adjusted if the "solenoid type" is set to "**proportional solenoid**"

Field	Parameter description	Range / Step
Cable break solenoid	Switch the solenoid output cable break detection on or off	on off
solenoid current I-min ("I" means Current)	Setting of the minimum solenoid current I-min (equal to the current at 0% command) Should usually be set to the opening point of the valve according to the valve data sheet.	0 ... 2500mA 0 ... I _{max}
solenoid current I-max ("I" means Current)	Setting of the maximum solenoid current I-max (equal to the current at 100% command) Should usually be set to the nominal current of the solenoid according to the valve data sheet.	0 ... 2500mA I _{min} ... 2500mA I _{max} > I _{min}
Dither frequency	The dither frequency can be adjusted in steps	4, 6, 8, 10, 12, 14, 16, 18, 20, 25, 30, 35, 40, 45, 50, 55, 60, 70, 80, 100, 125, 165, 250, 500Hz
Dither level	Leve/Amplitude of the super-imposed Dither signal	0 ... 400mA
	<p>The superimposed Dither holds the armature tube of the solenoid very small constant vibration. This reduces the "stick/slip" effect, improves hysteresis and allows higher sensitivity also for small command changes.</p> <p>Optimum dither settings are depending on the valve type, and also on the hydraulic system.</p> <p>A too strong dither (low frequency and high level) will create an unintended direct hydraulic oscillation.</p> <p>A too weak dither (high frequency and low level) will have little effect and will increase stick/slip effect and hysteresis.</p>	

The following settings can only be adjusted if the "solenoid type" is set to "**switching solenoid**"

Field	Parameter description	Range / Step
On threshold	Command > On threshold = solenoid output active	0 ... 100%
Off threshold	Command < Off threshold = solenoid out put not active	0 ... 100%
Reduction time	When switched on, the solenoid output stays fully on for this defined time. After this time, the solenoid current is reduced to the "reduced value". See section " power reduction " ¹⁴ .	0 ... 2000ms
Reduced value	After the defined "reduction time", the solenoid current is reduced to the this PWM ratio. See section " power reduction " ¹⁴ .	0 ... 100%

7.5 Wandfluh App

The Wandfluh App allows wireless diagnostics and parameterisation of the PD3 electronics via Bluetooth on a Smartphone oder Tablet



The functions of the App include:

- retrieve the latest Wandfluh News
- scan and connect to the PD3 electronics
- full parameterisation
- read out possible device errors
- monitor online data values
- save and load device parameter settings
- apply software updates
- configure the access control
- define password
- change device name and other device specific settings

7.5.1 Installation

The Wandfluh App is available both for iOS in the [AppStore](#) as well as for Android in [Google Play](#). The App runs on Smartphones and Tablets and supports the languages English, German and French.



7.5.2 Pairing / Connection

The App allows to connect to one PD3 electronic which is located within the Bluetooth sending/receiving range.

Proceed as follows to connect the App to the PD3:

1. download the newest version of the App, install and start the App.
2. open the "Device configurator" **(A)** in the main menu, and allow the permissions if asked so.
3. switch the PD3 electronics ON, and verify that the blue LED is flashing (if not, press the push-button on the PD3)
4. select "Start scan" **(B)** in the App. (PD3 must be within the Bluetooth Range)
5. all the available PD3s appear in the list; tap the desired PD3 now **(C)** to connect.
6. the blue LED will turn permanently ON and indicate the active Bluetooth connection.

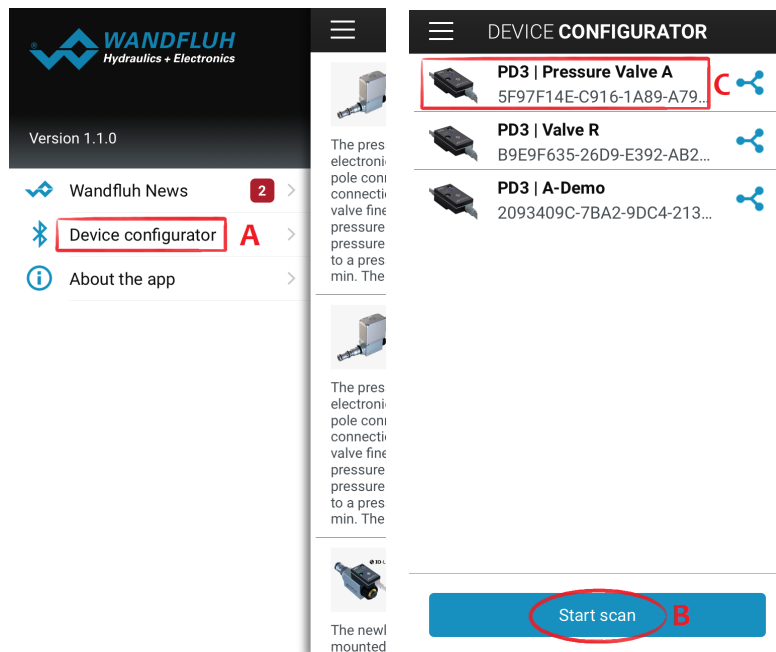

Caution:

If the blue LED is permanently ON, a Bluetooth connection is active, and no additional connection can be established.

Disconnect

To disconnect the App from the PD3, simply tap on the main menu **(D)**. The connection is terminated, and the Scanning view comes up again.

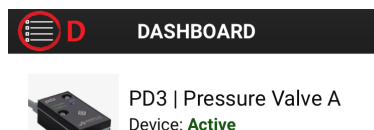

Permission

The Wandfluh App requires access to the Bluetooth interface as well as to the device location. The App itself does not use the location function, but the Bluetooth technology requests this access.

Version conflicts

It is important to use the latest version of the App.

If the PD3 uses a newer Firmware than the App, then the App will tell you to update to the latest App version.

If a critical firmware update for the PD3 is available, it will be installed automatically upon connection with the App.

7.5.3 Dashboard

The Dashboard offers an overview to the online data of the PD3 electronics.

All values with the "live" badge are refreshed periodically and thus show the current, actual values of the PD3.

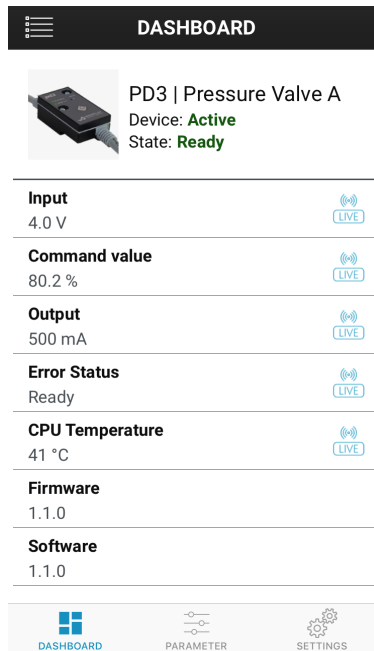

The screenshot shows a dashboard for a device named "PD3 | Pressure Valve A". The device is active and in a ready state. The dashboard displays several key metrics:

Metric	Value	Refresh Status
Input	4.0 V	LIVE
Command value	80.2 %	LIVE
Output	500 mA	LIVE
Error Status	Ready	LIVE
CPU Temperature	41 °C	LIVE
Firmware	1.1.0	
Software	1.1.0	

At the bottom of the dashboard, there are three navigation icons: DASHBOARD (selected), PARAMETER, and SETTINGS.

Error State

A potential device error will be showed.

Header

The header of the Dashboard shows the most important informations about the PD3.

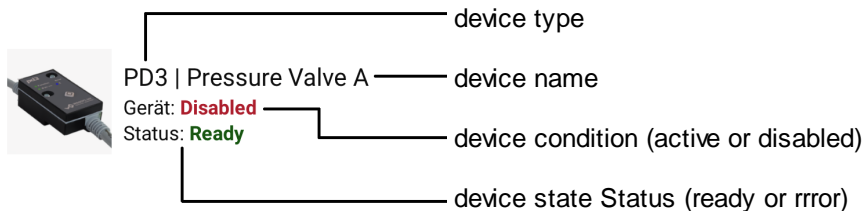

The diagram illustrates the components of the dashboard header for a device:

- device type**: PD3
- device name**: Pressure Valve A
- device condition (active or disabled)**: Gerät: Disabled
- device state Status (ready or rror)**: Status: Ready

7.5.4 Parameter

All parameter of the PD3 electronics can be changed in the "Parameter" tab. The parameters are divided in 3 groups: Input, Functions, Output.

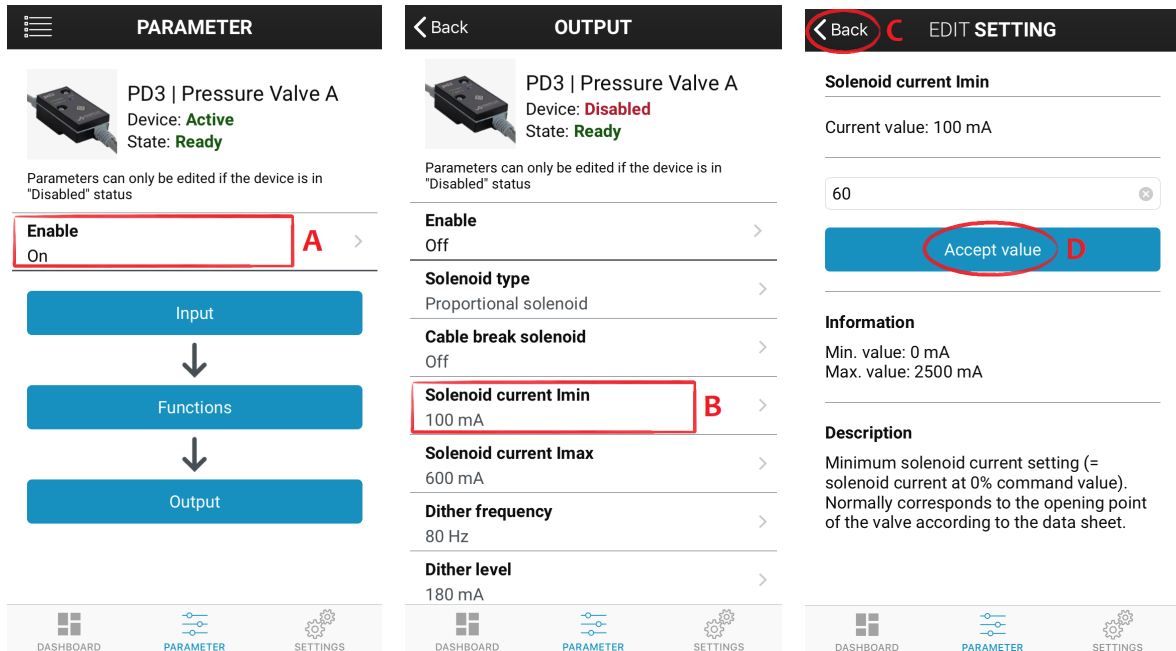

Enable

Most parameters can only be changed in the device condition "Disable". Set the Enable Input (A) to "Off" to switch to the "disable" state.

Access parameters

Tap the parameter (B) to change it's value.

In this edit mode, all the information about this parameter will be available:

minimum and maximum value, description of the parameter, and possibly depending other parameters.

The new value is sent to the PD3 and takes effect after tapping "Accept value" (D).

When quitting the Edit mode without accepting the values, the changes are discarded and not sent to the PD3.

Password protection

If a password has been set, then this password must be entered once per session to change any parameter.

7.5.5 Settings

The Tab "Settings" allows to change the PD3 specific settings.

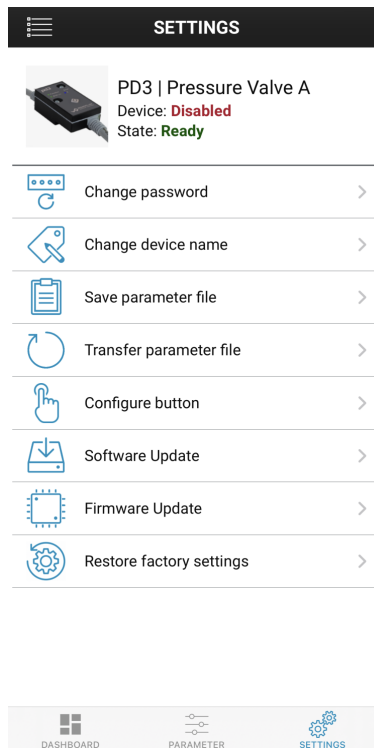

- **Change password**
 Set or change the password on the PD3.
 The password will then be used for access protection of the PD3 parameters.
 To connect the App to the PD3, and to read the parameter values, the password is not required.
 But to change a parameter value, the App will ask for the password (if a password has been set previously).
- **Change device name**
 This name will be listed when scanning for different PD3.
 It allows a unique identification of the PD3 and the solenoid valve.
- **Save parameter file**
 The current parameters of the PD3 can be saved as a parameter file directly in the App.
- **Transfer parameter file**
 A previously saved parameter file can be loaded, and then be transmitted to the PD3.
- **Configure butto**
 This setting allows to define the time while the PD3 is waiting for a Bluetooth connection to the Wandfluh App.
 The time begins to run after the power-up of the PD3, or after pushing the button. This is a security feature and allows the connection only during the defined time.
 As an option (but not recommended!), the Bluetooth setting can be configured as "always ON".
- **Restore factory settings**
 The original factory setting parameters of the PD3 are restored;
 subsequently, the Bluetooth connection will be disconnected.
- **Firmware Update**
 If recommended by Wandfluh, this setting allows to perform a firmware update of the PD3.

8 System does not work

This section describes the possible errors and causes, and explains the procedure to recover from an error.

8.1 Procedure

In case of an error, please consult the following check list.

Any active error will be shown as follows:

- flashing red LED on the PD3 (see "flashing code" below)
- the Header of the App shows the state "Error" (or "Ready" when OK)
- The Dashboard shows the current error state

Error	Possible fault	Flashing code
Voltage error logic or Voltage error solenoid	<p>The power supply voltage is below 18 VDC (type IO-Link, logic supply) or below 8VDC (type Analog and solenoid supply).</p> <ul style="list-style-type: none"> • is the supplied power sufficient? • is the AC voltage part too high? (refer to section "Electrical specifications" (6)) <p>This error is automatically cleared if the power supply is higher than 18 VDC or 8VDC respectively.</p>	1 x
Short circuit solenoid	<ul style="list-style-type: none"> • too high current / solenoid output has a short circuit • after curing the short circuit, clear the error by shortly disabling and enabling the PD3 (or switch power off/on) 	3 x
Memory error	<ul style="list-style-type: none"> • internal memory error • if occurring while sending parameters, retry again, and switch the power off / on • if occurring after power-up, try to switch power off / on again 	4 x
Fieldbus error	<ul style="list-style-type: none"> • an error related to IO-Link has occurred • reset or restart the IO-Link connection, or switch power off / on 	5 x
Cable break solenoid	<ul style="list-style-type: none"> • no connection to the solenoid coil, solenoid output cable break • after curing the cable break, clear the error by shortly disabling and enabling the PD3 (or switch power off/on) 	6 x
Temperature error	<ul style="list-style-type: none"> • the temperature of the PD3 is higher than 90°C • the solenoid has been operated with a too high current and has overheated the PD3, or/and the ambient temperature is too high • check ambient temperature and setting of the solenoid current, and let the PD3 cool down • after curing the error, clear the error by shortly disabling and enabling the PD3 (or switch power off/on) 	6 x

9 Disposal

- The PD3 Electronics have to be disposed of in accordance with the generally applicable regulations of that country, in which it is being used.
- Electronics components are recycled by companies specialised in this field.

10 Accessories

Wandfluh App
for parameterisation and diagnostics,
and for Wandfluh News

see [Wandfluh App](#) 

11 Additional information

You can find additional information in the following Wandfluh documentation:

www.wandfluh.com

Wandfluh-Electronics general	Documentation A	Register	1.13
Proportional solenoid with PD3	Documentation A	Register	1.1
Proportional directional control valves	Documentation A	Register	1.10
Proportional pressure control valves	Documentation A	Register	2.3
Proportional flow control valves	Documentation A	Register	2.6